

ENVIRONMENT FRIENDLY AND HEALTHY

Dual-use Laser Cutting Machine P-T Series

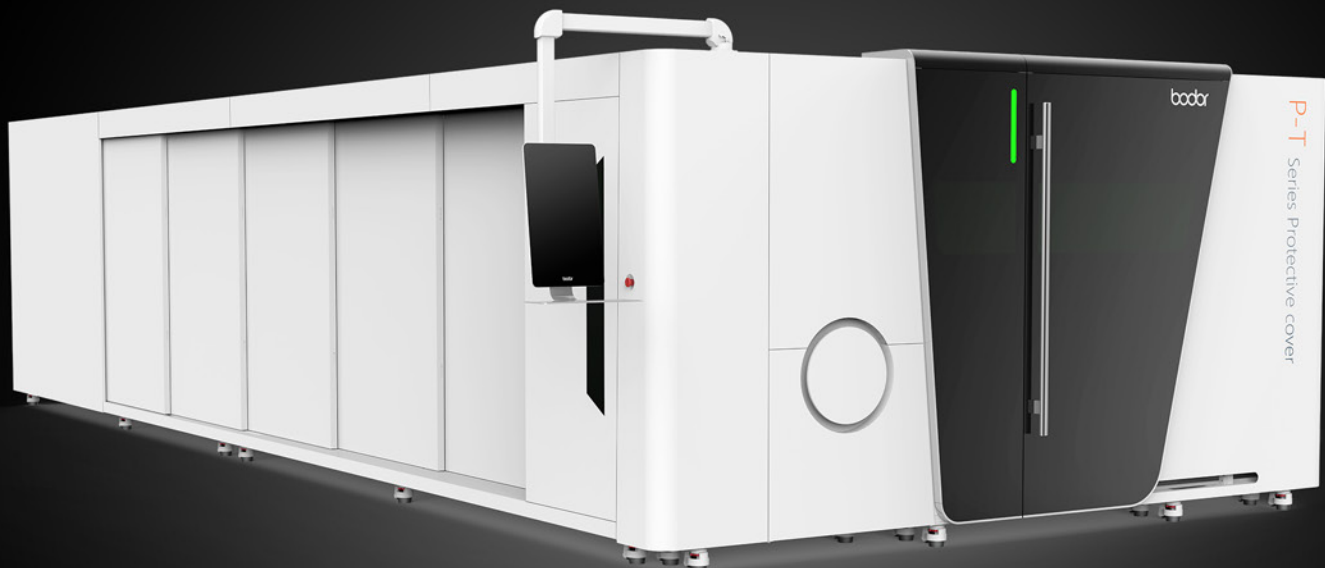

Dual-use Laser Cutting Machine P-T Series

The equipment meets the parts processing requirements of most industries, working accuracy is stable. Selecting the optimal force and supporting structure, the overall mechanical property of equipment is perfect. Adopting cutting-edge optical concept to improve cutting performance. High speed cutting, auxiliary loading and unloading and efficient production reduce labor costs. At present, laser cutting machines have been widely used in electronics, electrical, mechanical hardware, new energy lithium, packaging, solar, LED, automotive and other industries.

Product parameters

Model	P3015T
Working area	3000mm*1500mm
laser power	4000W/3000W/2500W/2000W/1000W
Max. linkage speed	100m/min
X/Y-axis positioning accuracy	0.03mm
X/Y-axis repositioning accuracy	0.02mm

A CAST IRON BED LASTS FOREVER.

No deformation in a life cycle



Material is more suitable



Technique is more suitable

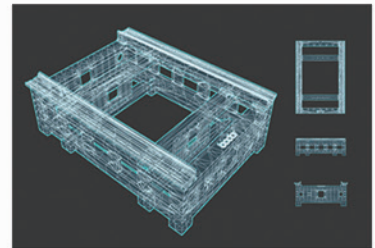

Structure is more reasonable

Clone

Mold pouring, clone production; integrally formed, reject splicing

Durable

Using flake graphite cast iron, the lowest tensile strength of which is 200MPa. High carbon content, high compressive strength and high hardness. Strong shock absorption and wear resistance. Low thermal sensitivity and bed gap sensitivity reduce the loss of equipment in using, so the machine accuracy could maintain for a long time, and no deformation in a life cycle.



Bodor Genius • Auto focus laser head

FREE YOUR HANDS , ENJOY **AUTO** FOCUS

To be the forerunner of the world laser industry, to change human life with laser technology !

AUTO - FOCUS

Applicable to various focal lengths, which are controlled by machine tool control system. Focal point will be automatically adjusted in cutting process to achieve the best cutting effect of different thicknesses sheets metal.

Free

Free your hands. Focal length is controlled by operating system. We don't need to do manual regulation, which effectively avoids errors or faults caused by manual operation.

Fast

Adopt Bodor Lightning technology, perforation time is short, 90% of perforation time is saved; Bodor Lightning combined with Bodor Genius improved new process so that the perforation is not affected by the material quality and achieve perfect cutting with the best cutting section; saving cutting gas and electricity, saving cost.
When replacing different materials or different thicknesses sheet, manual focus laser head needs to adjust focal length manually, very inefficient; auto focus laser head can read system storage parameters automatically, very efficient.

Accuracy

Increasing perforation focus length, separately setting perforation focal length and cutting focal length, enhance cutting accuracy.

Durable

Built-in double water-cooling structures can ensure constant temperature of collimating and focusing components, avoid lenses overheating and extend service life of lenses;
Increasing collimation protective lens and focus protective lens, carefully protect key components.

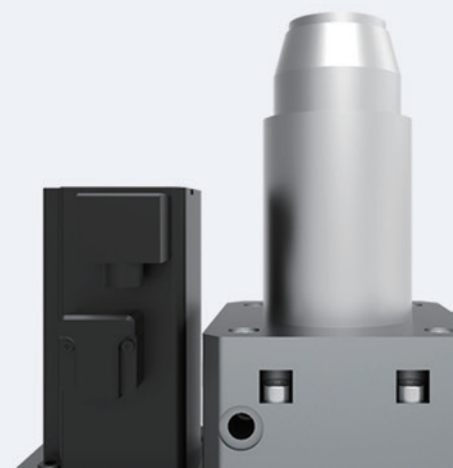

GEAR DRIVE , 10S EXCHANGE, NO.1 IN THE INDUSTRY

TWO AUTOMATIC EXCHANGE PLATFORMS SYSTEM



Dual-use Laser Cutting Machine P-T Series

Rapid exchanging between two platforms greatly improve work efficiency. Rack and pinion transmission system has better rigidity and higher accuracy, saving feeding time, making operation more efficient. The highest speed of platform exchanging is 10s.

Large surrounded structure

Environment friendly and Healthy



Large surrounded structure improves using security; laser protection glass isolates laser radiation to human beings; automatic collection system of smokes and dusts is environment friendly; intelligent monitoring system reduces accident rate, making us enjoy beauty and health in cutting process.

MANGO

Wireless Remote Control Handle



Wireless remote control equipment

Mobile phone size can meet one-handed operation

Elegant curves fit the hand palm well

Magnetic design can be adsorbed on the machine bed at any time, available at all times

Mango shape is lively and vivid



ENVIRONMENT FRIENDLY AND HEALTHY

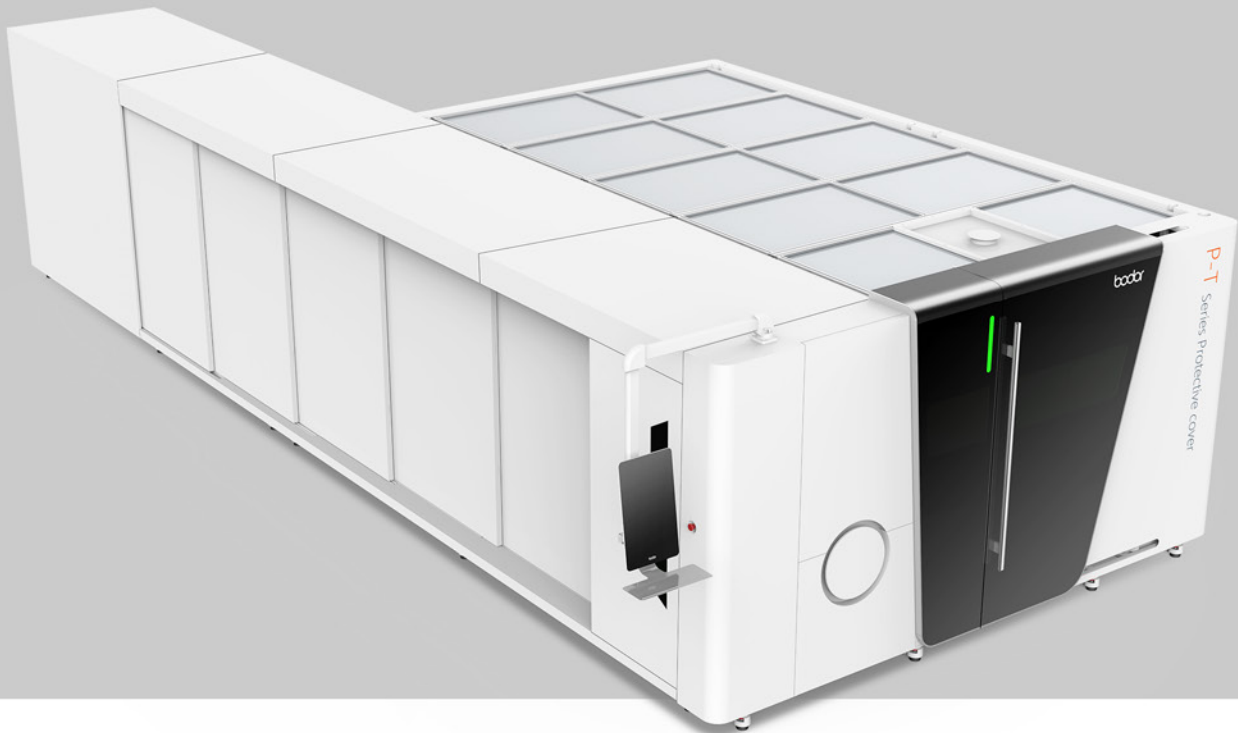

Full protection cover

Full closed protection improves using security; laser protection glass isolates laser radiation to human beings; automatic collection system of smokes and dusts is environment friendly; intelligent monitoring system reduces accident rate, making us enjoy beauty and health in cutting process.

Bodor Pro2.0



Bodor pro2.0

Adhering to "simple, acme, fast" of BODOR laser, the interface of BodorPro2.0 is more affinity, closer to user, and paying more attention to user experience.

Optimizing functions and algorithms makes system more stable and efficient! Dual-camera monitoring gathers processing interface and monitor interface at one.

One software with two configurations, plane cutting and tubing cutting can switch freely.

BodorPro2.0 optimized equipment, integrated compatibility and equipment perfectly, and made the system more stable, smooth and efficient.

It adopted the basic architecture of windows platform and fully inherited operating habits of office, reducing the operator's threshold.

Registration through mobile phone is convenient, fast and safer.



AUTOMATIC NOZZLE CHANGER



Automatic Cleaning



Automatic Replacement



Automatic Calibration

Automatic Nozzle Changer, Let Machine Know More About You

Adopting abundant and accurate control system can realize automatic replacement of nozzles according to different materials and thicknesses, saving manual replacement time and improving processing efficiency, smart and convenient; Newest automatic calibration and cleaning functions can achieve fully automatic laser head calibration and nozzle cleaning, reducing the repetitive manual work; High-precision drive system provides a reliable replacement precision and stability to ensure that every replacement can be perfectly safe. Fully enclosed protection of the whole part improves the safety of parts and personal.

SELF-CENTERING CHUCK



Self-centering Chuck

Automatic electric chuck, claw DC motor drive, clamping motor current is sensitive, adjustable and stable, clamping range is wider and clamping force is larger. Non - destructive pipe clamping, fast automatic centering and clamping pipe, performance is more stable. The chuck size is smaller, rotation inertia is low, and dynamic performance is strong. Self-centering electric chuck, gear transmission mode, higher transmission efficiency, long working life and high work reliability.



OPERATING SYSTEM DISPLAY

Operating system display

The first one to use UI design in the world which lets display respond to processing table, making processing more intuitive. Elegant curves precisely fit machine body. Strong waterproof breathable system creates the best space, making operation more convenient. Diamond cutting process and HD plasma tempered glass make screen more exquisite and comfortable to use.

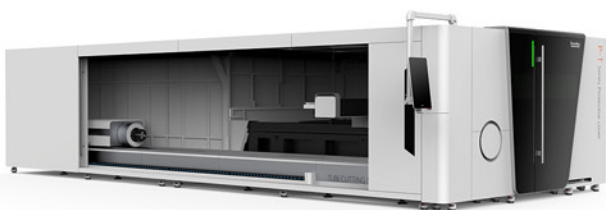
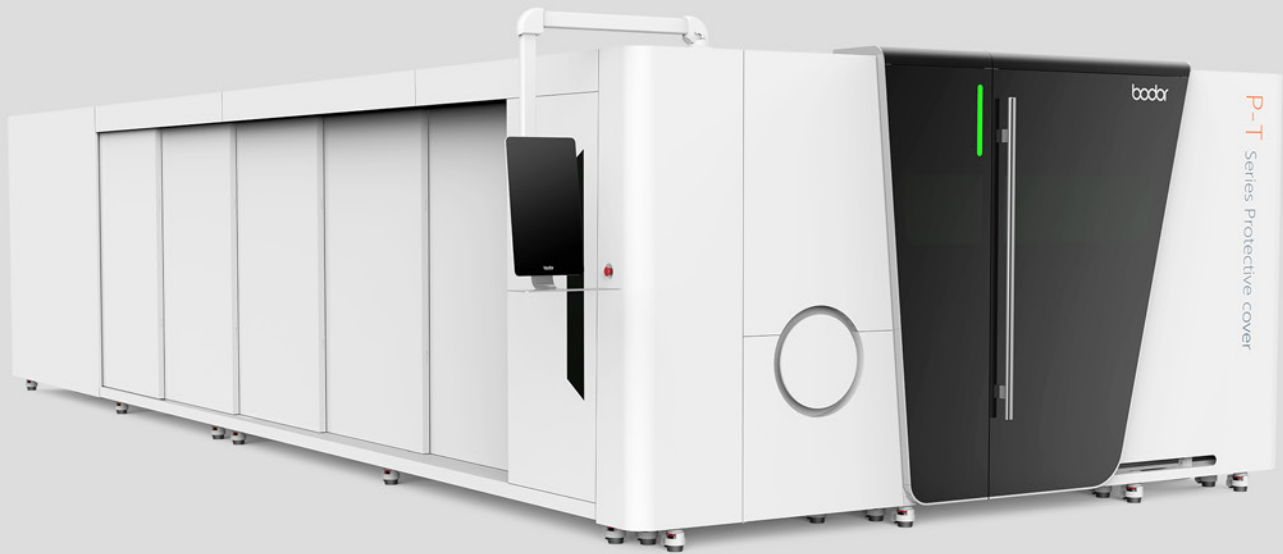

Appearance design

Aesthetics was introduced to industrial ID, perfect combination of technology and aesthetics.

Powerful hockey stick shaped decorations adopt black acrylic with thickness of 30mm, ice film drawbench silver design of the same car and alpine white sheet metal, the international design style is accepted by global consumer groups. With precise cast iron bed, the whole machine is as firm as a rock. The most treasonable golden ratio and the greatest parts layout make the whole machine more stable, comfortable, accurate, and technological. PC head capsule design through vacuum hot deformation processing makes Z axis so light.

CAST ALUMINUM CROSSBEAM

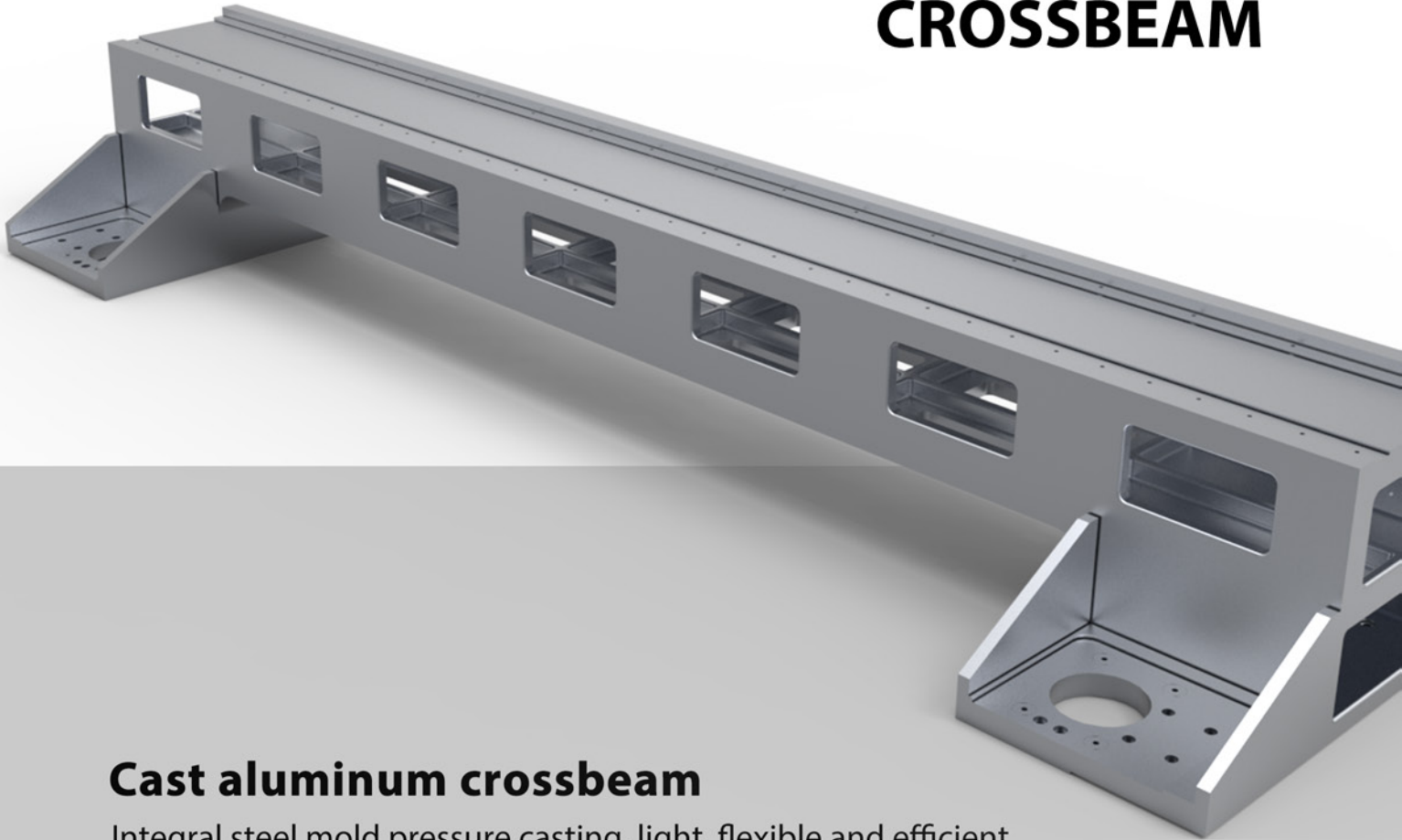

Cast aluminum crossbeam

Integral steel mold pressure casting, light, flexible and efficient

After artificial aging, solution treatment and finishing, crossbeam owns good integrity, rigidity, surface quality, toughness and ductility. Aluminum alloy's metal characteristics of light weight and strong rigidity are helpful to high speed movement in processing, and high flexibility is beneficial to high-speed cutting of various graphics based on high accuracy. Light crossbeam can give equipment a high operation speed, improving processing efficiency to ensure processing quality.

FUNCTIONS

The heavy bed makes the equipment more stable in working, the light crossbeam makes it work faster; perfect industrial design is more in line with man-machine engineering; high quality electrical software control system gives equipment higher cutting precision. The machine owns more comfortable operation, more stable performance, more durable quality, higher cutting efficiency and wider application scope.

Auxiliary feeding mechanism

The promotion and demotion of subsidiary roller table reduces friction force between parts and working table, making loading and unloading more convenient.

Intelligent travel protection

Automatically monitor operation range of crossbeam and cutting parts, keeping operation within machining range. Double guarantees of fixed limitation greatly improve equipment and personal safety, minimizing the using risks.

Automatic lubrication system

Automatic lubrication system provides timing and ration lubricating oil for equipment to ensure its normal and high speed operation, and owns functions of abnormal alarm and liquid level alarm. The system greatly enhances cutting accuracy and effectively extends service life of transmission mechanism.

WIFI remote intelligent assistance

Global real-time feedback ; Providing real-time fault analysis and troubleshooting.

A new generation of safety following module

Laser head keeping distance with work piece in cutting process can reduce collision risks. It will stop cutting when colliding plate. The safety following module reduces accident rate and improves cutting performance.

Intelligent alarm system

The system will start full abnormal alarm and push it to the interface through control center when equipment is abnormal.

Finding equipment abnormal in advance and reducing hidden dangers can multiply improve the equipment troubleshooting efficiency.

Auxiliary gas low pressure alarm function

Providing real-time pressure detection, pushing abnormal information when pressure value is lower than optimal cutting effect and precision. Ensure the cutting performance, accuracy and timeliness of gas replacement.

THE ADVANTAGES OF LASER CUTTING MACHINE

- 1, high-speed, high efficiency, high performance
- 2, high precision, low cost, easy to operate
- 3, a wide range of processing materials, advanced processing technology, flexibility and strong
- 4, energy saving, easy maintenance, low operating costs
- 5, high cost, service standards
- 6, independent research and development software, simple operation, safety, stable performance
- 7, reasonable structure, leading technology, superior performance, computing speed, perfect function.
- 8, reasonable structure, easy operation, stable operation of the laser, low maintenance costs

Laser cutting has the advantage over traditional cutting

- 1, high precision: focusing accuracy of 0.05mm, repeated focusing accuracy of 0.02 mm
- 2, narrow slit: the laser beam is focused into a small spot, so that the focus to achieve high power density, the material quickly heated to the degree of gasification, evaporation to form a hole. As the beam moves linearly relative to the material, the holes continue to form narrow-width slits. Cutting width is generally 0.10 ~ 0.20mm.
- 3, cutting surface smooth: cutting surface without burr, incision surface roughness generally controlled within Ra12.5.
- 4, good cutting quality: non-contact cutting, trimming little affected by heat, the basic no thermal deformation of the workpiece, completely avoid the formation of the material when the red edge cutting, kerf generally do not need secondary processing.
- 5, does not damage the workpiece: the laser cutting head will not be in contact with the surface of the material to ensure that no scratches the workpiece.

Contrast with other cutting advantages

- 1, wire cutting: high precision, piercing difficulties, slow cutting speed. Equipment investment is not big. A device from tens of thousands to tens of thousands or so
- 2, laser cutting: high precision, speed with a great impact on board thickness, generally less than 10 m / min. Thick plate can not cut (generally 25MM below), equipment into large. Suitable for high-volume processing
- 3, water cutting: the accuracy is quite high, the speed is quite slow. Not suitable for mass production and processing. Equipment investment is relatively large.
- 4, plasma cutting: high precision (product verticality is not high), fast, consumables fast. Suitable for high-volume processing. Equipment into the general.
- 5, flame (oxygen) cutting: precision (thermal deformation large), slow, but can cut a lot of cutting at the same time, suitable for high-volume processing. Equipment into small, cheaper operating costs.
- 6, Punch: less variety of products more difficult, less obvious advantages of large quantities of products. Thick board cutting difficult. Cost input in general.
- 7, shearing machine: curved cutting not, straight cut OK, thick plate has difficulty.

P3015T • FLOOR PLAN

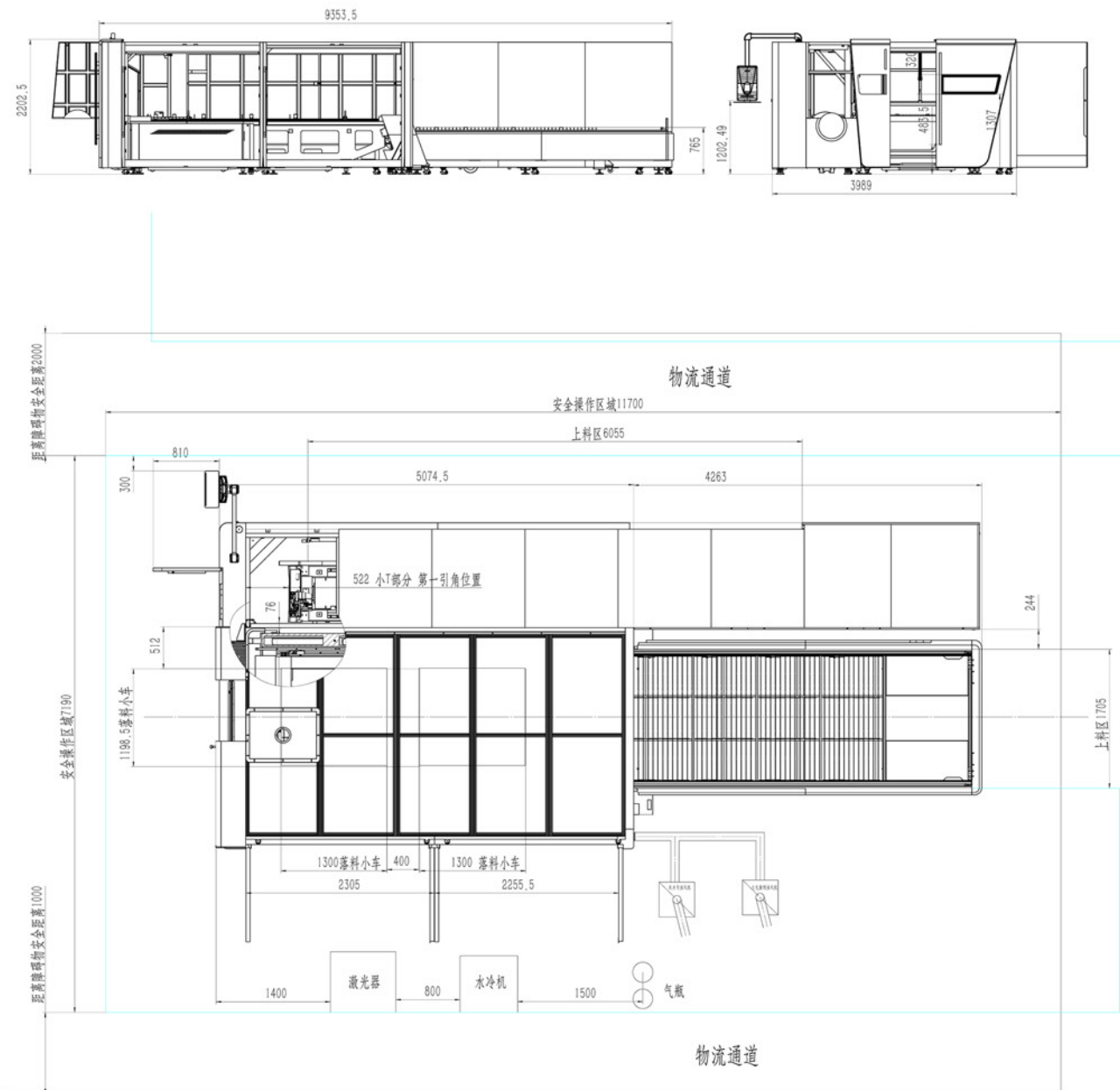

PLACING REQUIREMENT

- 1.The whole machine should keep away from obstacles at least 1m
- 2.The whole machine should be far away from the hypocenter
- 3.The planeness of placing field should be less than 5mm
- 4.Voltage fluctuation of the whole machine should be kept in $\pm 5\%$

Cutting Capacity

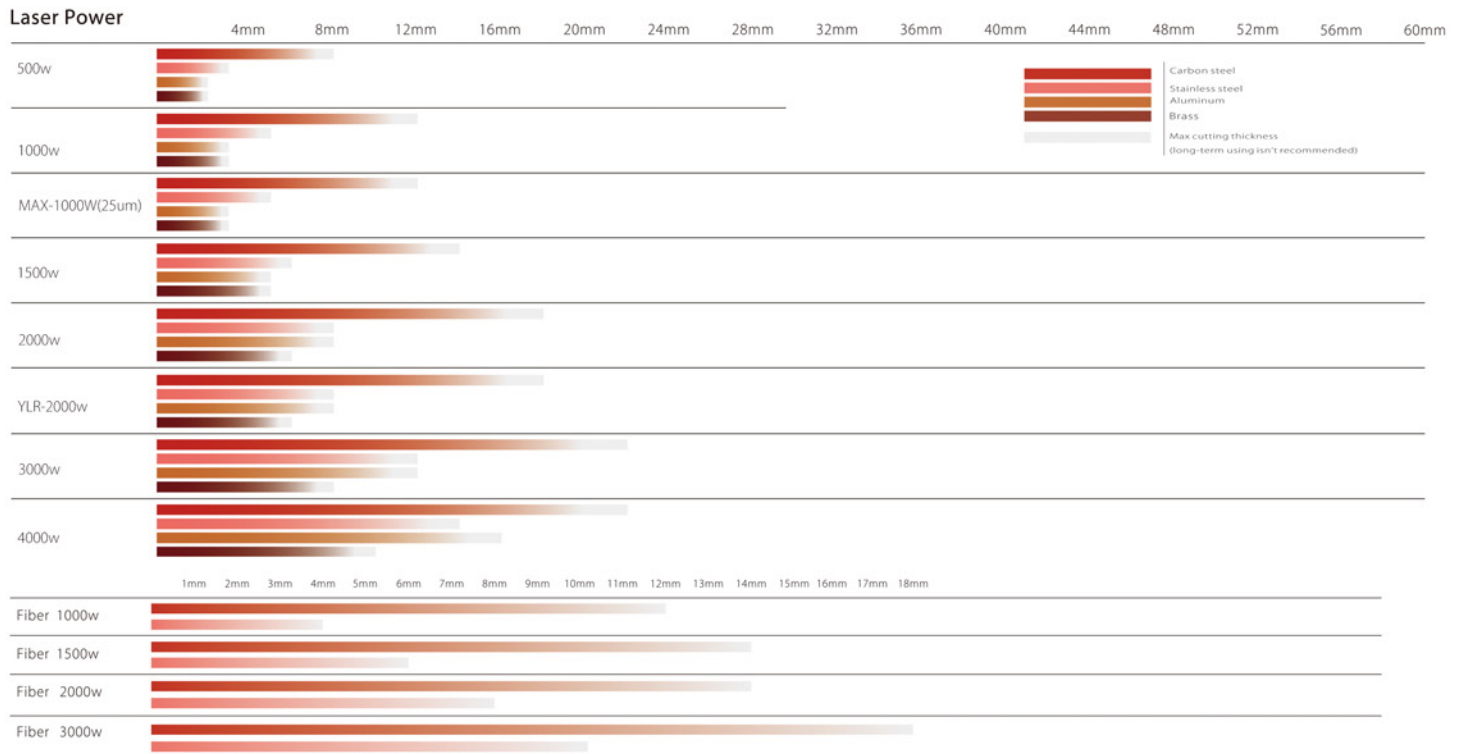

Fiber Laser Cutting Process Parameters

Material	Thickness	500W	1000W	MAX-1000W(25um)	1500W	2000W	YLR-2000W	3000W	4000W						
		speed m/min	speed m/min	speed m/min	speed m/min	speed m/min	speed m/min	speed m/min	speed m/min	speed m/min	1000W	1500W	2000W	3000W	
Carbon steel (Q235A)	1	7.0-9.0	8.0-10	8.0-10 02/24-36H2	15-26	24-30	24-32	30-40	33-43	Material	Thickness (mm)	speed m/min	speed m/min	speed m/min	speed m/min
	2	3.0-4.5	4.0-6.5	4.5-7.0	4.5-6.5	4.7-6.5	4.7-6.5	4.8-7.5	15-25						
	3	1.8-3.0	2.4-3.0	2.4-3.0	2.6-4.0	3.0-4.8	3.0-4.8	3.3-5.0	7.0-12						
	4	1.3-1.5	2.0-2.4	2.0-2.4	2.5-3.0	2.8-3.5	2.8-3.5	3.0-4.2	3.0-4.0						
	5	0.9-1.1	1.5-2.0	1.5-2.0	2.0-2.5	2.2-3.0	2.2-3.0	2.6-3.5	2.7-3.6						
	6	0.6-0.9	1.4-1.6	1.4-1.6	1.6-2.2	1.8-2.6	1.8-2.6	2.3-3.2	2.5-3.4						
	8	0.3-0.7	0.8-1.2	0.8-1.2	1.0-1.4	1.2-1.8	1.2-1.8	1.8-2.6	2.0-3.0						
	10		0.6-1.0	0.6-1.0	0.8-1.1	1.1-1.3	1.1-1.3	1.2-2.0	1.5-2.4						
	12		0.5-0.8	0.5-0.8	0.7-1.0	0.9-1.2	0.9-1.2	1.0-1.6	1.2-1.8						
	14				0.5-0.7	0.7-0.8	0.8-1.0	0.9-1.4	0.9-1.2						
	16					0.6-0.7	0.6-0.8	0.7-1.0	0.8-1.0						
	18					0.4-0.6	0.5-0.7	0.6-0.8	0.6-0.9						
	20							0.5-0.8	0.5-0.8						
	22							0.3-0.7	0.4-0.8						
	25														
30															
Stainless steel (201)	1	8.0-13	18-25	24-36	20-27	24-30	24-50	30-35	32-45	Carbon steel	Thickness (mm)	speed m/min	speed m/min	speed m/min	speed m/min
	2	2.4-5.0	5-7.5	6-10	8.0-12	9.0-12	9.0-15	13-21	16-28						
	3	0.6-0.8	1.8-2.5	2.2-3.5	3.0-5.0	4.0-6.5	4.8-7.5	6.0-10	7.0-15						
	4		1.2-1.3	1.2-1.6	1.5-2.4	3.0-4.2	3.2-4.5	4.0-6.0	5.0-8.0						
	5		0.6-0.7	0.6-0.75	0.7-1.3	1.8-2.5	2.0-2.8	3.0-5.0	3.5-5.0						
	6				0.7-1.0	1.2-1.8	1.2-2.0	2.0-4.0	2.5-4.5						
	8					0.7-1.0	0.7-1.0	1.5-2.0	1.2-2.0						
	10							0.6-0.8	0.8-1.2						
	12							0.4-0.6	0.5-0.8						
	14								0.4-0.6						
	16														
	18														
	20														
	25														
	30														
40															
50															
Aluminum	1	4.0-5.5	6.0-10	6.0-10	10-20	15-25	20-30	25-38	35-45	Stainless steel	Thickness (mm)	speed m/min	speed m/min	speed m/min	speed m/min
	2	0.7-1.2	2.8-3.6	2.8-3.6	5.0-7.0	7-10	10-15	10-18	13-24						
	3		0.7-1.5	0.7-1.5	2.0-4.0	4.0-6.0	5.0-7.0	6.5-8.0	7.0-13						
	4				1.0-1.5	2.0-3.0	3.5-5.0	3.5-5.0	4.0-5.5						
	5				0.7-1.0	1.2-1.8	1.8-2.5	2.5-3.5	3.0-4.5						
	6					0.7-1.0	1.0-1.5	1.5-2.5	2.0-3.5						
	8					0.6-0.8	0.6-0.8	0.7-1.0	0.9-1.6						
	10							0.4-0.7	0.6-1.2						
	12							0.3-0.45	0.4-0.6						
	16								0.3-0.4						
	20														
	25														
	30														
	40														
	50														
60															
Brass	1	4.0-5.5	6.0-10	6.0-10	8.0-13	10-16	12-18	20-35	25-35	Stainless steel	Thickness (mm)	speed m/min	speed m/min	speed m/min	speed m/min
	2	0.5-0.9	2.8-3.6	2.8-3.6	3.0-4.5	4.5-7.5	6.0-8.5	6.0-10	8.0-12						
	3		0.5-1.0	0.5-1.0	1.5-2.5	2.5-4.0	2.5-4.0	4.0-6.0	5.0-8.0						
	4				1.0-1.6	1.5-2.0	1.5-2.0	3.0-5.0	3.2-5.5						
	5				0.5-0.7	0.9-1.2	0.9-1.2	1.5-2.0	2.0-3.0						
	6					0.4-0.7	0.4-0.9	1.0-1.8	1.4-2.0						
	8							0.5-0.7	0.7-1.2						
	10								0.2-0.5						
	12														
	14														
16															
18															
20															
25															



TO BE THE FORERUNNER OF THE WORLD LASER INDUSTRY,
TO CHANGE HUMAN LIFE WITH LASER TECHNOLOGY!

Application Industry

The equipment meets the parts processing requirements of most industries, working accuracy is stable. At present, laser cutting machines have been widely used in electronics, electrical, mechanical hardware, new energy lithium, packaging, solar, LED, automotive and other industries.



Sheet metal processing



Solar



Automotive



Electrical



Kitchenware profession



Packaging



New energy lithium

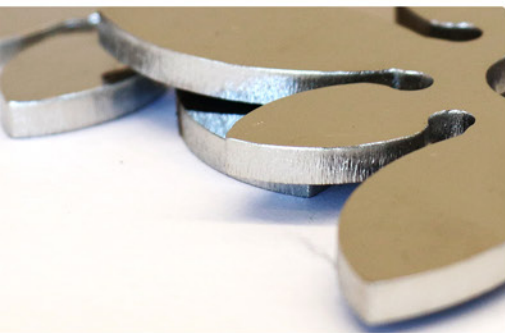

Metal Samples

For more information, please go to the website : www.bodor.com



OFFICE

For more information, please go to the website : www.bodor.com

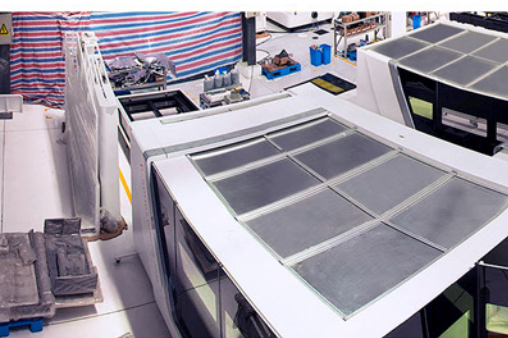

WORKSHOP

For more information, please go to the website : www.bodor.com